

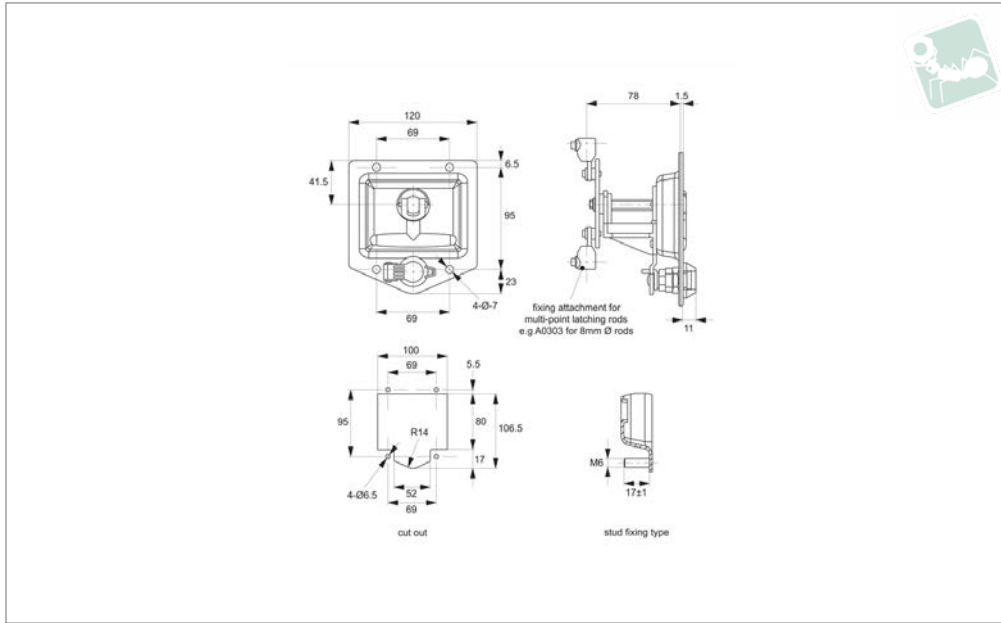

Cam Latch - Flush T-handle - Rod

vertical - heavy duty- fixed grip - standard cylinder



PL0580

LATCHES

Material

Body: stainless steel, AISI 303.
 Handle: die cast zinc, chrome plated.
 Cylinder lock: die cast zinc, chrome plated.
Supplied with: Keys: two per lock.

Technical Notes

Hole fixing type requires 4 off M 6 screws

(not supplied) for front mounting.
 Stud fixing type has 4 off M 6 welding studs for rear mounting with M 6 nuts (not supplied).
 Use with multi-point latching rods (e.g. CC0340), with 8mm Ø rods, to achieve two point latching of larger enclosure panels.

Tips

Ideal for electricity sub-stations, HGVs and other road side vehicles.
 T-handle is in the vertical position when locked. Universal left/right. For use inside of cabinet gasket.

Order No.	Mounting type	Lock type	Key type
PL0580.M0010	Hole Fixing	Std. Cylinder	Keyed Alike
PL0580.M0020	Stud Fixing	Std. Cylinder	Keyed Alike

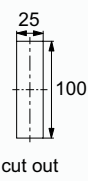



Cylinder Profile	Body	Locking System	Use	Cam Type
Std. Cylinder Lock	Die-Cast Zinc	1-point	Inside Gasketing	With Projection
40mm Euro	Polyamide Plastic	2-point	Outside Gasketing	W/O Projection
Padlockable	Stainless Steel	3-point		
Insert Driver	Steel			
	Aluminium			
	IP Rating			

B1180 - Swing Handle

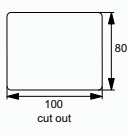

Cams: A0203, A0224, A0240 - Keys: Supplied



Cylinder Profile	Body	Locking System	Use	Cam Type
Std. Cylinder Lock	Die-Cast Zinc	1-point	Inside Gasketing	With Projection
40mm Euro	Polyamide Plastic	2-point	Outside Gasketing	W/O Projection
Padlockable	Stainless Steel	3-point		
Insert Driver	Steel			
	Aluminium			
	IP Rating			

B4590 - Cam Latch - Flush T-handle - Heavy Duty



Cams: Supplied - Keys: Supplied

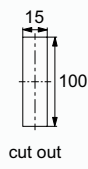

Cylinder Profile	Body	Locking System	Use	Cam Type
Std. Cylinder Lock	Die-Cast Zinc	1-point	Inside Gasketing	With Projection
40mm Euro	Polyamide Plastic	2-point	Outside Gasketing	W/O Projection
Padlockable	Stainless Steel	3-point		
Insert Driver	Steel			
	Aluminium			
	IP Rating			

B4584 - Cam Latch - Flush T-handle, Vertical - Heavy Duty



Cams: Supplied - Keys: Supplied

B4586 - Cam Latch - Flush T-handle, Vertical - Heavy Duty



Cams: Supplied - Keys: Supplied

B4588 - Cam Latch - Flush T-handle, Vertical - Heavy Duty



Cams: Supplied - Keys: Supplied



Models available



Cam Latch - Flush T-Handle with rod control for multi-point latching



Cam Latch - Flush T-Handle for single point latching



Cam Latch - Flush T-Handle with adjustable grip



Cam Latch - Concealed T-Handle for electricity panels

Variety of materials

- Steel.
- Stainless steel.
- Aluminium.
- Polyamide.

Actuation/locking method

- Blank, without lock.
- Standard cylinder Lock.
- Padlockable T-Handle actuation.

Features

- Heating & ventilation.
- Generators.
- Compressors.
- Machine covers.

- Electric panels.
- Off-road equipment.
- Industrial transport.
- Special equipment cases.

Applications